

OPTIKA[®]

B A L A N C E S
I T A L Y

INSTRUCTION MANUAL

Models

CNS001-CNS002-CNS003-CNS004

FOR

SMG/AG/BG/CG/CGH/DG/EG/EGH/FG/GG

v 1.0 2019

CE

INDEX

1	INTRODUCTION	2
1.1	PACKAGE CONTENTS.....	2
2	INSTALLATION OF THE DENSITY DETERMINATION KIT	3
3	DENSITY DETERMINATION PRINCIPLE	4
4	CONDITIONS FOR PRECISE MEASUREMENTS	5
4.1	DRIFT OF THE SCALE'S INDICATION	5
4.1.1	<i>CALIBRATION OF THE SCALE WITH EXTERNAL CALIBRATION</i>	5
4.1.2	<i>CALIBRATION OF THE SCALE WITH INTERNAL CALIBRATION</i>	6
5	DETERMINATION OF THE DENSITY OF SOLID BODIES	7
5.1	FUNDAMENTALS	7
5.2	PREPARATION OF THE KIT FOR THE DETERMINATION OF SOLIDS.....	7
5.3	PREPARE THE SCALE FOR THE AUTOMATIC CALCULATION OF THE DENSITY OF SOLIDS.....	8
5.4	FACTORS THAT INFLUENCE THE MEASUREMENT ERROR	10
5.4.1	<i>PRESENCE OF AIR BUBBLES</i>	10
5.4.2	<i>TEMPERATURE</i>	10
5.4.3	<i>SURFACE TENSION OF THE LIQUID</i>	10
5.4.4	<i>POROSITY OF THE SOLID</i>	11
6	DETERMINATION OF THE DENSITY OF LIQUIDS	12
6.1	FUNDAMENTALS	12
6.2	PREPARATION OF THE KIT FOR THE DETERMINATION OF LIQUIDS	12
6.3	PREPARE THE SCALE FOR THE AUTOMATIC CALCULATION OF THE DENSITY OF LIQUIDS.	13
6.4	FACTORS THAT INFLUENCE THE MEASUREMENT ERROR	15
6.4.1	<i>PRESENCE OF AIR BUBBLES</i>	15
7	TABLE OF THE DENSITY OF DISTILLED WATER	16

1 INTRODUCTION

Thank you for purchasing the kit for the determination of the density of solids and liquids. These instructions explain how to install and use the density determination kit.

CAUTION:



Please read these installation and use instructions carefully before beginning your work. Use of the instrument different from that reported in this manual no longer guarantees the safety of the product and the correctness of the measurements.

1.1 PACKAGE CONTENTS

The density determination kit contains the following elements:

BASKET SUPPORT

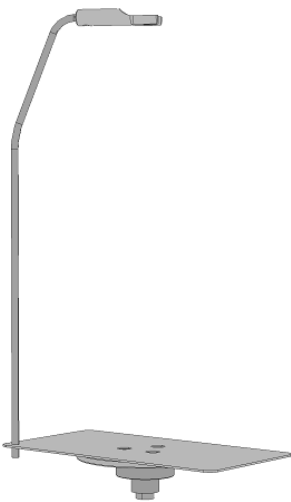

WEIGHING BASKET



BEAKER SUPPORT

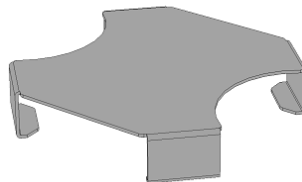

FLOAT CARRIER

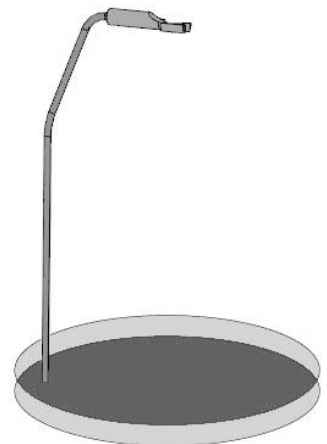

BEAKER FOR SOLIDS



BEAKER FOR LIQUIDS



THERMOMETER



FLOAT

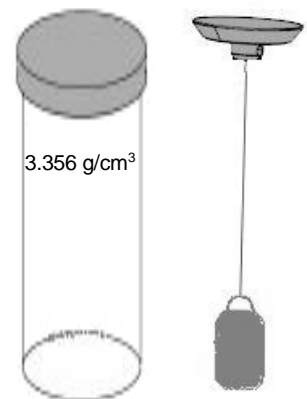

2 INSTALLATION OF THE DENSITY DETERMINATION KIT

ASSEMBLY PHASES

Remove the standard weighing plate and underplate.

Position the basket support on the weighing cone.

Position the beaker support, taking care that it does not touch the basket support at any point.

Position the beaker at the center of the beaker support.

Install the weighing basket in the upper part of the basket support.

CG/EG/FG/GG VERSION

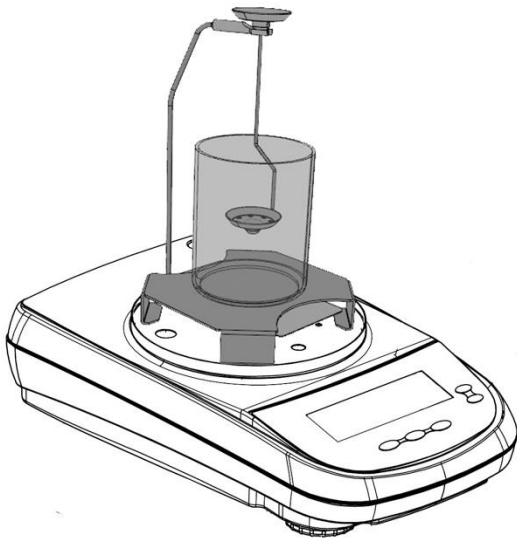

BG/CGH/EHG/EHF VERSION

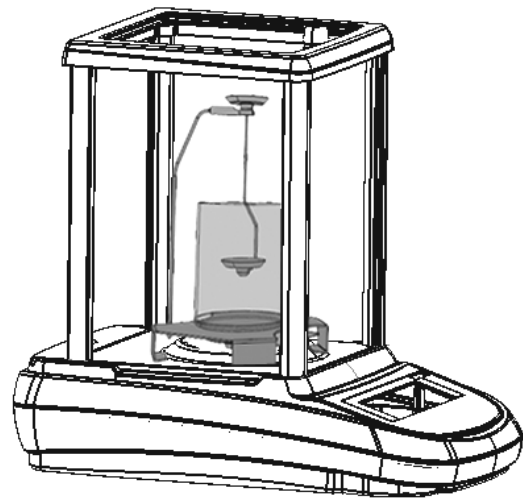

3 DENSITY DETERMINATION PRINCIPLE

The density [ρ] is the ratio of the mass [M] and volume [V].

0

$$\rho = \frac{M}{V}$$

The international system of measurement units indicates kg/m^3 as the unit of measure of density. However, the unit g/cm^3 is more suitable for laboratory use.

Archimedes' principle is applied for the determination of the density. According to this principle, a body immersed in a fluid apparently loses weight in an amount equal to the weight of the fluid that it displaces.

The density determination procedure differs depending on whether you want to determine the density of a solid or a liquid.

4 CONDITIONS FOR PRECISE MEASUREMENTS

Situations that cause measurement errors may occur during the determination of the density. It is essential to follow the indications below to obtain precise results using this density determination kit.

4.1 DRIFT OF THE SCALE'S INDICATION

Precise weighing values are required when determining the density of liquids with the use of the glass float. The scale must be calibrated if the temperature varies or the scale is repositioned. This requires removing the weighing kit, positioning the instrument's standard weighing plate and following the calibration procedures described below.

4.1.1 CALIBRATION OF THE SCALE WITH EXTERNAL CALIBRATION

External calibration

The calibration is carried out through the CAL button.

1. Press the **CAL** button with the plate empty; the writing CAL will be displayed.

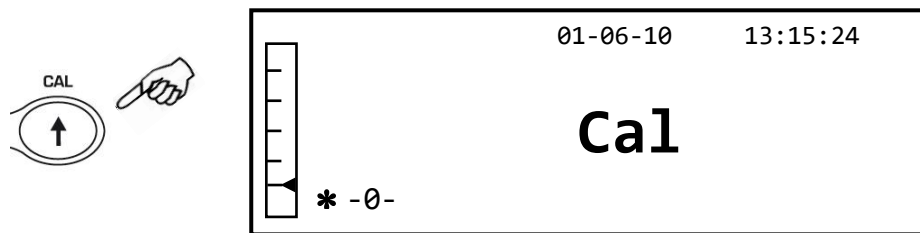

2. When the value of the calibration weight begins to flash, load the weight indicated by the display on the plate.

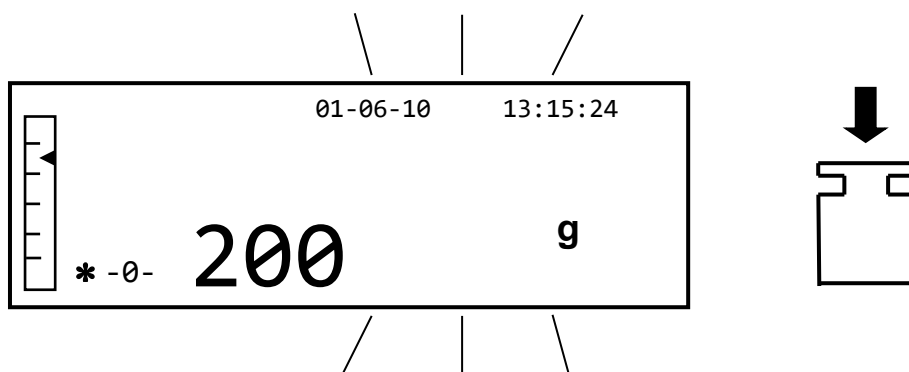

3. The display will stop flashing and will indicate the value of the calibration weight with the stability indicator shown.
Once the calibration has been carried out, the calibrated weight will be displayed with the indication of the current unit of measurement.
4. Remove the calibration weight.
The scale is ready for weighing operations.

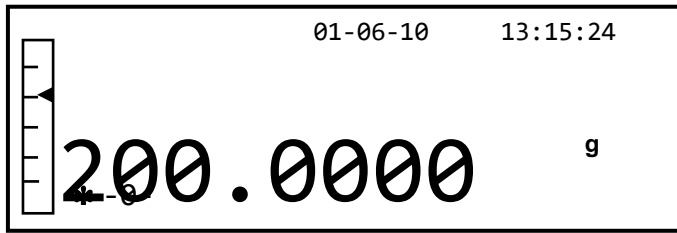

Note: if there is some interference during the calibration process, an error message will be displayed. Press the ON/OFF button while the indication of the calibration weight flashes to interrupt the calibration procedure.

4.1.2 CALIBRATION OF THE SCALE WITH INTERNAL CALIBRATION

Internal calibration

In these models the calibration is performed through an internal automatic system:

1. Press the **CAL** button with the plate empty.
The display will show the message "CAL" and the scale will then be automatically calibrated.

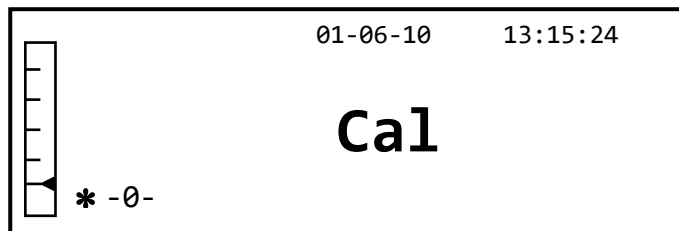
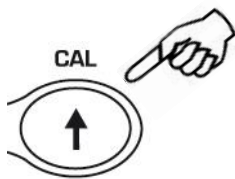

2. The scale will return to the normal weighing conditions at the end of the calibration.

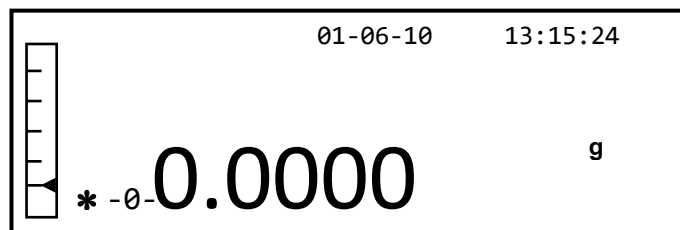

If the calibration is not completed due to vibrations or air currents, the message "CAL bUt" will be displayed. Press the **CAL** button again, and if the problem persists, select external calibration and contact the supplier.

5 DETERMINATION OF THE DENSITY OF SOLID BODIES

5.1 Fundamentals

The density of a solid is determined with the use of a liquid at known density (distilled water at a temperature of 20°C or ethanol). The solid sample is first weighed in air (A) and then in the liquid (B). The density ρ can be calculated starting from the two measured values:

Density:

$$\rho = \frac{A}{A-B} \rho_0$$

ρ = solid density

ρ_0 = known liquid density

A = solid weight in air

B = solid immersion weight

5.2 Preparation of the kit for the determination of solids

The use of the kit for the determination of the density of solids by using the scale's automatic calculation software is illustrated below. The calculation can also be performed manually by referring to the formula shown above.

For the determination of the density of solids, use the universal basket for floating and non-floating solids.

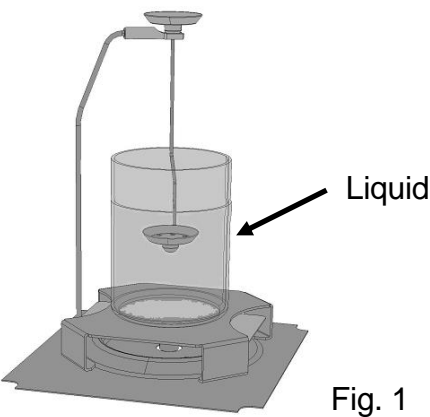
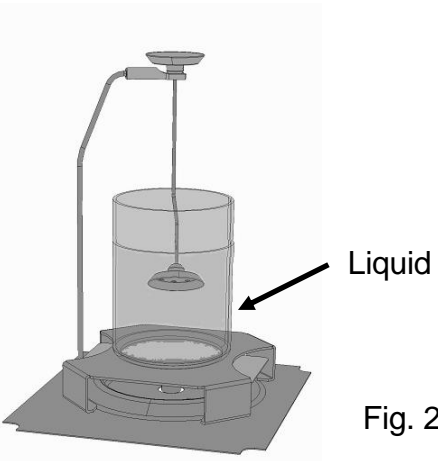
<p>00</p>  <p>Fig. 1</p>  <p>Fig. 2</p>	<p>Fill the beaker with the liquid of known density. Add liquid until the solid is covered by at least 1 centimeter after the immersion.</p> <p>House the support for solids as illustrated in Figure 1. This configuration is valid for solids with a density greater than 1; for floating solids the basket must be mounted upside down as shown in Figure 2, and a supplementary weight may need to be positioned in the upper part of the support to counteract the solid's force when it is greater than the weight of the support.</p> <p>Note: Make sure that there are no air bubbles on the surface of the immersed part of the basket and eliminate them if necessary by shaking the basket support.</p>
---	---

5.3 Prepare the scale for the automatic calculation of the density of solids.

1. Select the Density program by using the MENU button and then select the solids mode. The following screen will be shown on the display:

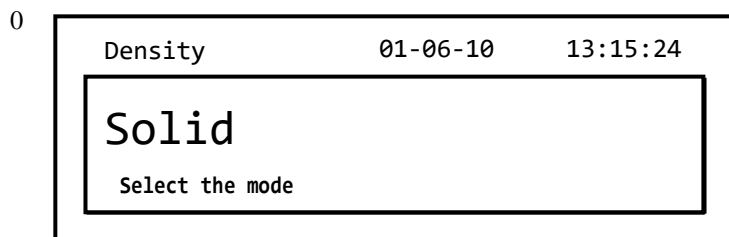

2. Then press the **PRINT** button to confirm the selection.
3. The value of the density of the liquid to be used will be displayed; by default the value is equal to 1.0000 (distilled water at 20°C).

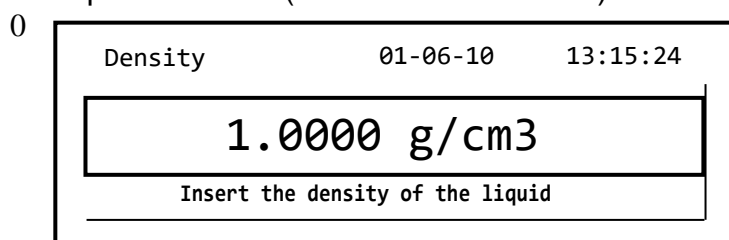

4. It is possible to set a different value by using the **CAL** and **MENU** buttons to increment and decrement the digit, while pressing the **O/T** button passes to the next digit. During the insertion phase, holding down the **O/T** button allows you to delete the inserted value.

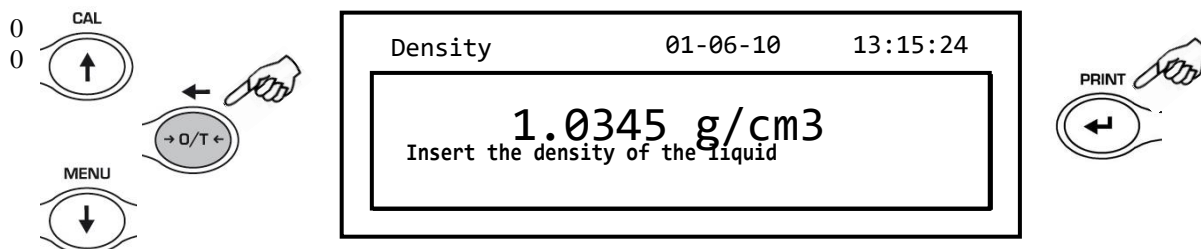

Note: It is also possible to easily set the value by using the optional external alphanumeric keypad (code AC005).

5. Once the desired value has been set, press the **PRINT** button.
6. The weighing of the solid in air will now be requested.

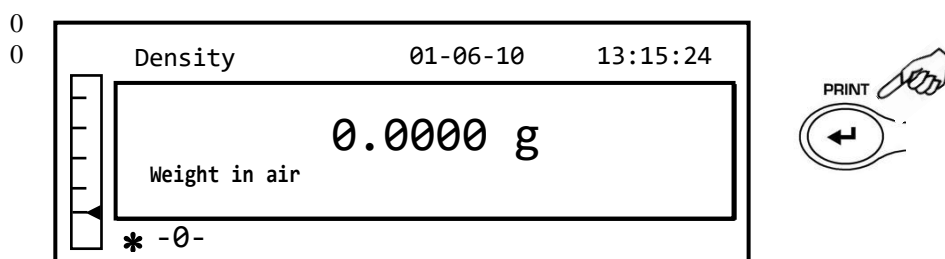

7. Perform a tare if necessary and load the solid in the upper basket. Wait for the stability

symbol to appear on the display and press the **PRINT** button to capture the value. The writing “pending...” will be displayed during the acquisition of the value.

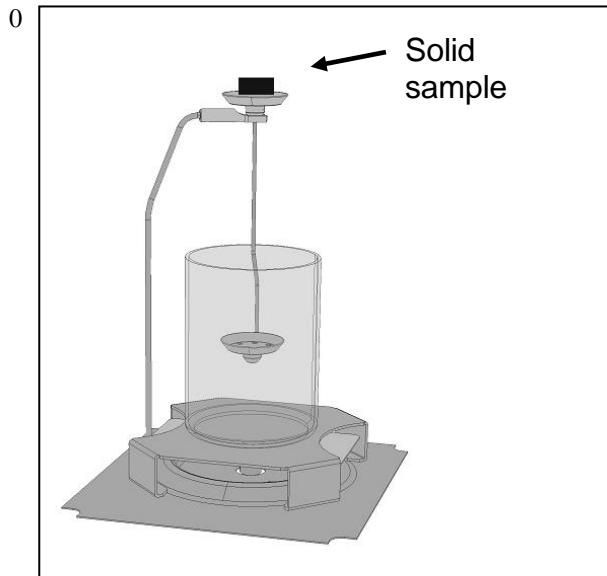

7. Remove the solid from the basket.
8. The weighing of the solid in the liquid will then be requested. Perform the taring of the basket in the liquid, position the solid in the lower basket immersed in the liquid, weight for the stability indicator to appear and press the **PRINT** button. The writing “pending...” will be displayed during the acquisition of the value.

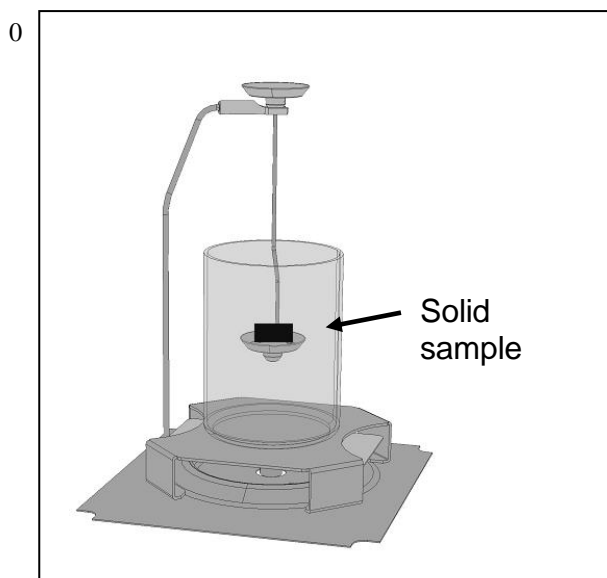
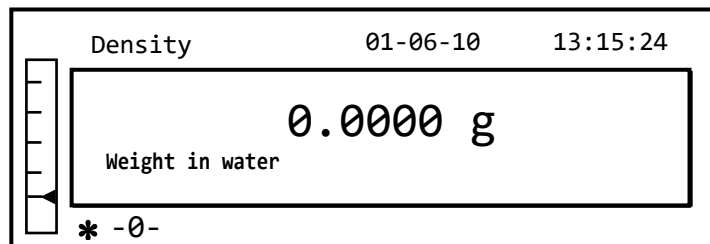

9. The result of the solid density calculation will now be displayed. If the scale is equipped

with a printer, it will be possible to print the density value by pressing the **PRINT** button.

0

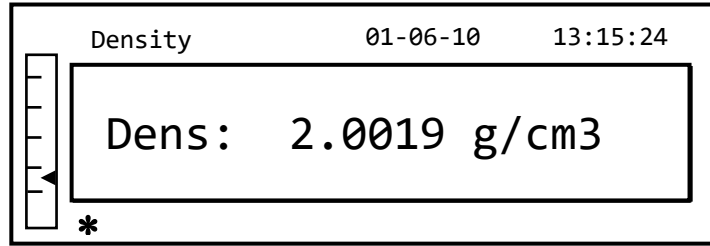

10. In the case of an error, the following string will be shown on the display:

0

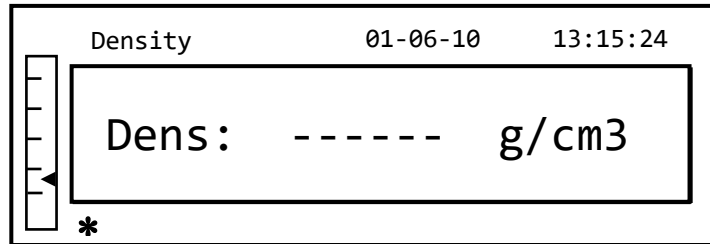

11. Now press the **ON/OFF** button to exit from the density function, or the **MENU** button to carry out the measurement of another solid.

5.4 FACTORS THAT INFLUENCE THE MEASUREMENT ERROR

5.4.1 PRESENCE OF AIR BUBBLES

During the measurement phases of the weight of bodies immersed in water, some small bubbles can form around the immersed body. Even the presence of small bubbles can cause large errors, especially with light samples. It is therefore necessary to guarantee that air bubbles do not adhere to the body immersed in the liquid.

To eliminate any air bubbles, shake the support immersed in the water or the float until all of the bubbles are eliminated.

The solid body samples and the float should not be touched with bare fingers so as to avoid dirtying the surfaces with grease or oil, as this can create air bubbles once they are immersed in the water.

5.4.2 TEMPERATURE

Solids are generally insensitive to temperature variations, so the relative density changes are negligible. However, for the liquid used in the determination of the density of solids, it is necessary to take the temperature into account as for every °C of variation the density varies on an order of magnitude from 0.1 to 1%. This effect indeed influences the third decimal digit of the result. The kit is equipped with a thermometer to measure the temperature value of the liquid, so detect the temperature and correct the value of the density of the liquid as described above on the basis of the value corresponding to the measured temperature. The table with the corresponding values for distilled water and ethanol at various temperatures is shown in Section 7.

5.4.3 SURFACE TENSION OF THE LIQUID

An apparent increase in weight is generated as a result of the adhesion of the liquid to the basket's support wire.

Given that the basket is immersed in the liquid during both the weighing of the solid in air and

in water, and that the scale is zeroed before each weighing, the effect can be neglected. For measurements with the greatest accuracy, use a few drops of dish detergent as a lubricating agent.

5.4.4 POROSITY OF THE SOLID

When a porous solid is immersed in a liquid not all of the air is completely expelled from the pores. This leads to incorrect values in the upward force, so the density of porous bodies can only be determined approximately.

6 DETERMINATION OF THE DENSITY OF LIQUIDS.

6.1 Fundamentals

The density of a liquid is determined with the use of a float of known volume. The float is first weighed in air and then in the liquid whose density you wish to determine. The density of the liquid can be calculated using a scale with the formula described below:

Density:

$$\rho_L = \frac{A-B}{A} \rho_s$$

ρ_L = liquid density

ρ_s = float density

A = weight of float in air

B = weight of immersed float

6.2 Preparation of the kit for the determination of liquids

The use of the kit for the determination of the density of liquids by using the scale's automatic calculation software is illustrated below. The calculation can also be performed manually by referring to the formula shown above.

Use the provided float for the determination of the density of liquids.

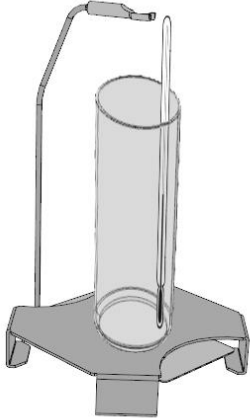
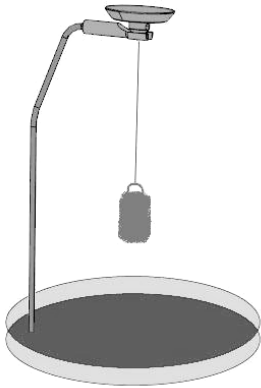
	<p>Position the beaker with the thermometer inside as shown in Figure 1.</p>
	<p>Remove the float from its container and position it on the float-bearing structure.</p>

6.3 Prepare the scale for the automatic calculation of the density of liquids.

1. Select the Density program by pressing the MENU button.
The following screen will be shown on the display:

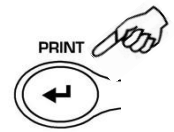
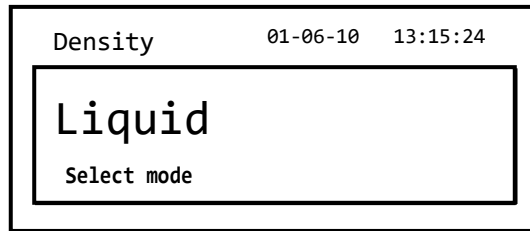
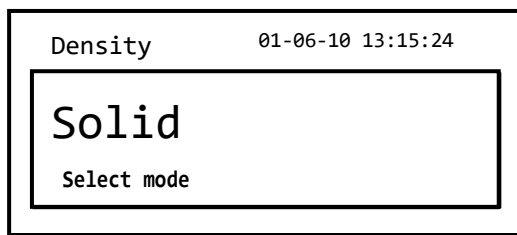

2. Press the **MENU** button to select liquid mode. Then press the **PRINT** button to confirm.
3. The value of the density of the solid will be displayed; by default the value is equal to 3.0000 g/cm³.

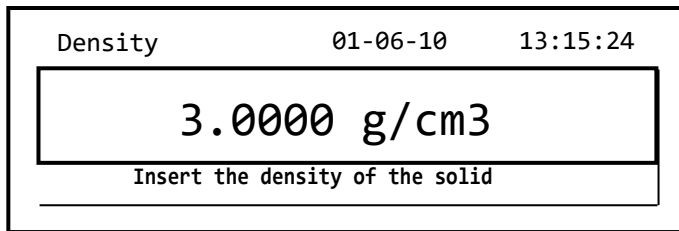

4. Insert the value indicated on the label placed at the top of the float, using the **CAL** and **MENU** buttons to increment and decrement the digit, and pressing the **O/T** button to pass to the next digit. During the insertion phase, holding down the **O/T** button allows you to delete the inserted value.

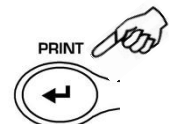
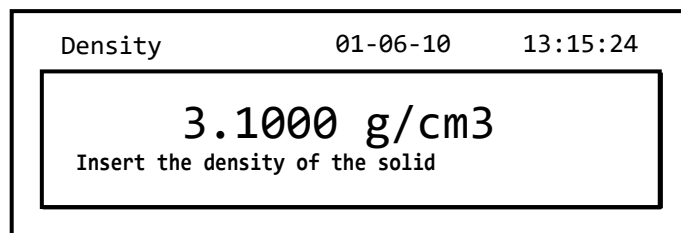
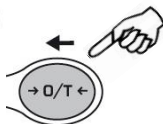

0

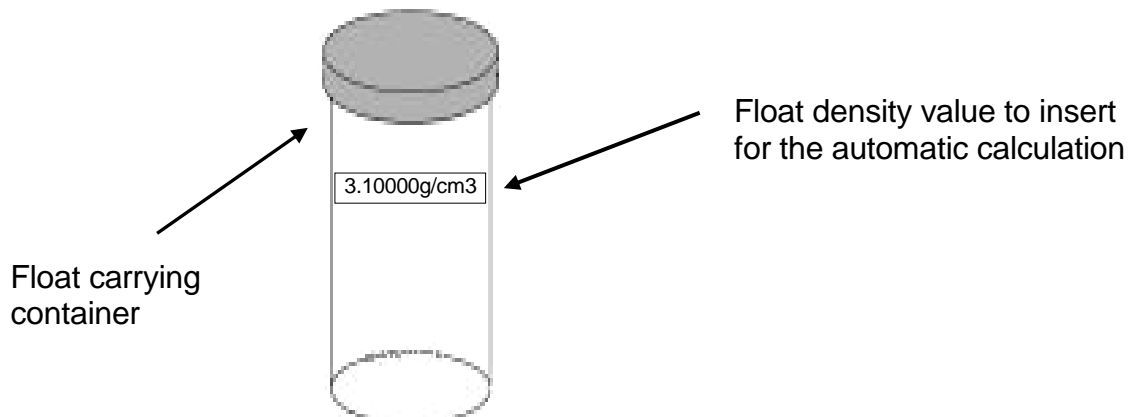

- Once the desired value has been set, press the **PRINT** button.
- The weighing of the float in air will now be requested.

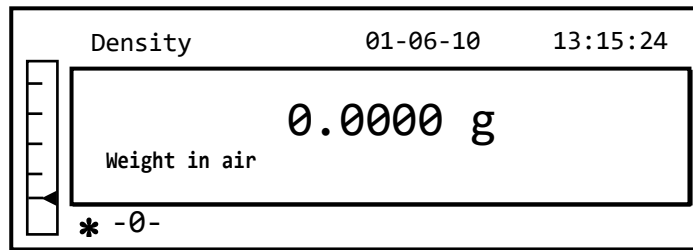

- Perform a tare if necessary and attach the float to the upper part of the arch as shown in the figure below. Wait for the stability symbol to appear and press the **PRINT** button to capture the value. The writing "pending..." will be displayed during the acquisition of the value.

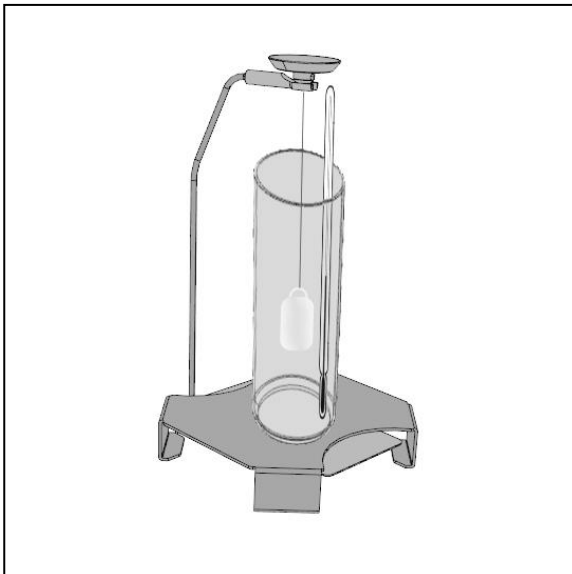

- Perform the tare if necessary and fill the beaker with the liquid whose density you wish to determine up to about 1 centimeter above the float as illustrated below. Make sure that there are no bubbles on the surface of the float and shake the float to remove them if necessary.



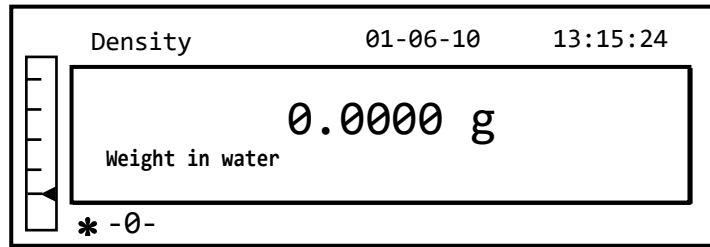

9. Wait for the stability indicator to appear and press the **PRINT** button. The writing “pending...” will be displayed during the acquisition of the value.

10. The result of the liquid density calculation calculated at the temperature indicated by the thermometer will now be displayed. If the scale is equipped with a printer, it will be possible to print the density value by pressing the **PRINT** button.

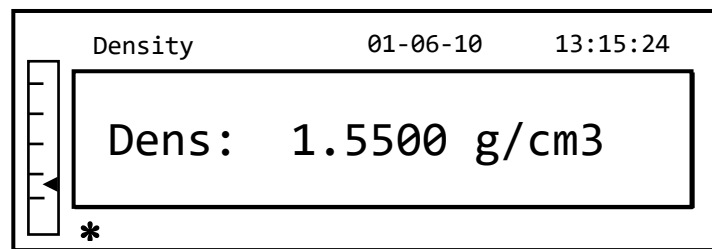

11. In the case of an error, the following string will be shown on the display:

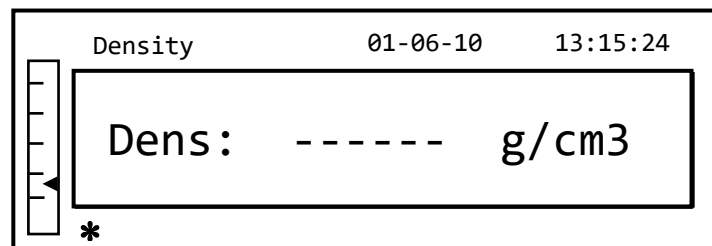

12. Now press the **ON/OFF** button to exit from the density function, or the **MENU** button to carry out the measurement of another liquid.

6.4 FACTORS THAT INFLUENCE THE MEASUREMENT ERROR

6.4.1 PRESENCE OF AIR BUBBLES

During the measurement phases of the weight of the float immersed in the liquid whose density you wish to determine, some small bubbles can form around the immersed body. Even the presence of small bubbles can cause significant errors. It is therefore necessary to guarantee that air bubbles do not adhere to the body immersed in the liquid.

To eliminate any air bubbles, shake the float or use a brush until all of the bubbles are eliminated.

The float should not be touched with bare fingers so as to avoid dirtying the surfaces with grease or oil, as this can create air bubbles once it is immersed in the water. Keep the float's surface clean after every measurement.

7 TABLE OF THE DENSITY OF DISTILLED WATER

Expressed in g/cm³

T(°C)	0.0	0.1	0.2	0.3	0.4	0.5	0.6	0.7	0.8	0.9
5	0.999965	0.999963	0.999961	0.999959	0.999957	0.999955	0.999952	0.999950	0.999947	0.999944
6	0.999941	0.999938	0.999935	0.999931	0.999927	0.999924	0.999920	0.999916	0.999911	0.999907
7	0.999902	0.999898	0.999893	0.999888	0.999883	0.999877	0.999872	0.999866	0.999861	0.999855
8	0.999849	0.999843	0.999837	0.999830	0.999824	0.999817	0.999810	0.999803	0.999796	0.999789
9	0.999781	0.999774	0.999766	0.999758	0.999751	0.999742	0.999734	0.999726	0.999717	0.999709
10	0.999700	0.999691	0.999682	0.999673	0.999664	0.999654	0.999645	0.999635	0.999625	0.999615
11	0.999605	0.999595	0.999585	0.999574	0.999564	0.999553	0.999542	0.999531	0.999520	0.999509
12	0.999498	0.999486	0.999475	0.999463	0.999451	0.999439	0.999427	0.999415	0.999402	0.999390
13	0.999377	0.999364	0.999352	0.999339	0.999326	0.999312	0.999299	0.999285	0.999272	0.999258
14	0.999244	0.999230	0.999216	0.999202	0.999188	0.999173	0.999159	0.999144	0.999129	0.999114
15	0.999099	0.999084	0.999069	0.999054	0.999038	0.999023	0.999007	0.998991	0.998975	0.998959
16	0.998943	0.998926	0.998910	0.998893	0.998877	0.998860	0.998843	0.998826	0.998809	0.998792
17	0.998774	0.998757	0.998739	0.998722	0.998704	0.998686	0.998668	0.998650	0.998632	0.998613
18	0.998595	0.998576	0.998558	0.998539	0.998520	0.998501	0.998482	0.998463	0.998444	0.998424
19	0.998405	0.998385	0.998365	0.998345	0.998325	0.998305	0.998285	0.998265	0.998244	0.998224
20	0.998203	0.998183	0.998162	0.998141	0.998120	0.998099	0.998078	0.998056	0.998035	0.998013
21	0.997992	0.997970	0.997948	0.997926	0.997904	0.997882	0.997860	0.997837	0.997815	0.997792
22	0.997770	0.997747	0.997724	0.997701	0.997678	0.997655	0.997632	0.997608	0.997585	0.997561
23	0.997538	0.997514	0.997490	0.997466	0.997442	0.997418	0.997394	0.997369	0.997345	0.997320
24	0.997296	0.997271	0.997246	0.997221	0.997196	0.997171	0.997146	0.997120	0.997095	0.997069
25	0.997044	0.997018	0.996992	0.996967	0.996941	0.996914	0.996888	0.996862	0.996836	0.996809
26	0.996783	0.996756	0.996729	0.996703	0.996676	0.996649	0.996621	0.996594	0.996567	0.996540
27	0.996512	0.996485	0.996457	0.996429	0.996401	0.996373	0.996345	0.996317	0.996289	0.996261
28	0.996232	0.996204	0.996175	0.996147	0.996118	0.996089	0.996060	0.996031	0.996002	0.995973
29	0.995944	0.995914	0.995885	0.995855	0.995826	0.995796	0.995766	0.995736	0.995706	0.995676
30	0.995646	0.995616	0.995586	0.995555	0.995525	0.995494	0.995464	0.995433	0.995402	0.995371

OPTIKA® S.r.l.

Via Rigla, 30 - 24010 Ponteranica (BG) - ITALY Tel.: +39 035.571.392
info@optika-italy.com - www.optika-italy.com
